

Ecovent[®] mini

- ▶ Compact Heat Recovery Units
- ▶ ErP 1253/2014 2018 Compliant
- ▶ Heat recovery efficiency up to 90%
- ▶ Low energy EC fans
- ▶ Compact design, lightweight construction, simple installation and easy maintenance
- ▶ Low SFP to help meet L2 Building Regulations
- ▶ Options for filter grades to suit a range of requirements
- ▶ Low noise to help meet acoustic requirements, including BB93
- ▶ Ancillary duct-mounted heating options
- ▶ Fitted BlueSense controls for simple installation
- ▶ BIM files available

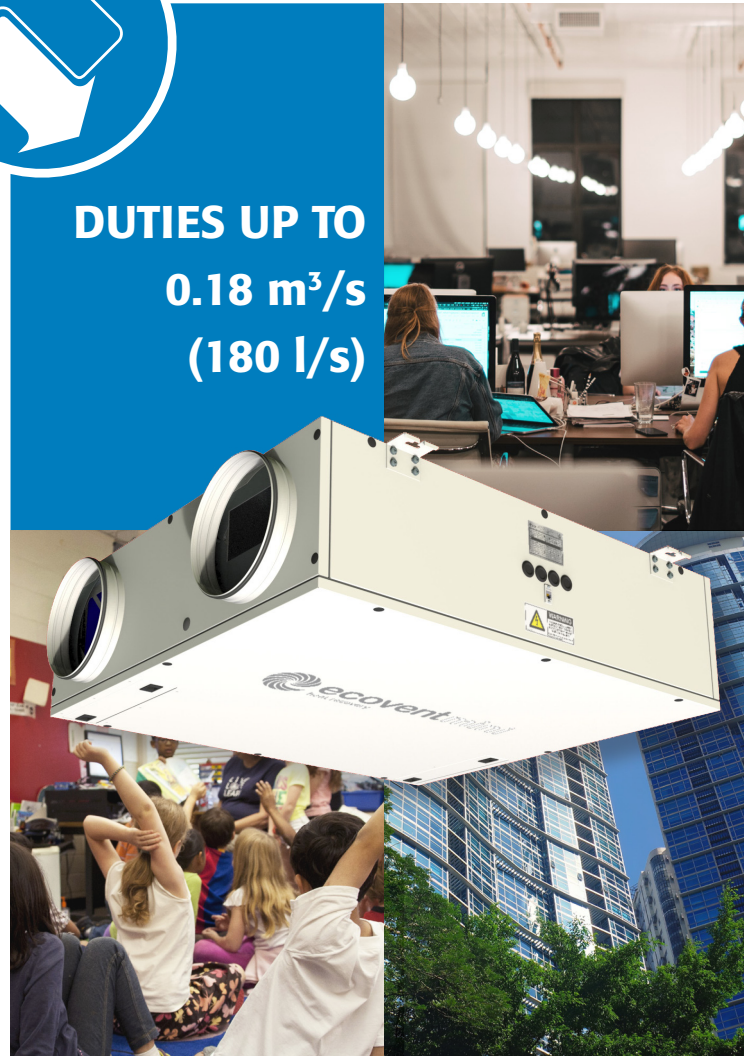

DUTIES UP TO
0.18 m³/s
(180 l/s)



Ecovent[®] mini

*part of the Ecovent range of innovative, flexible products
from the HVAC experts*









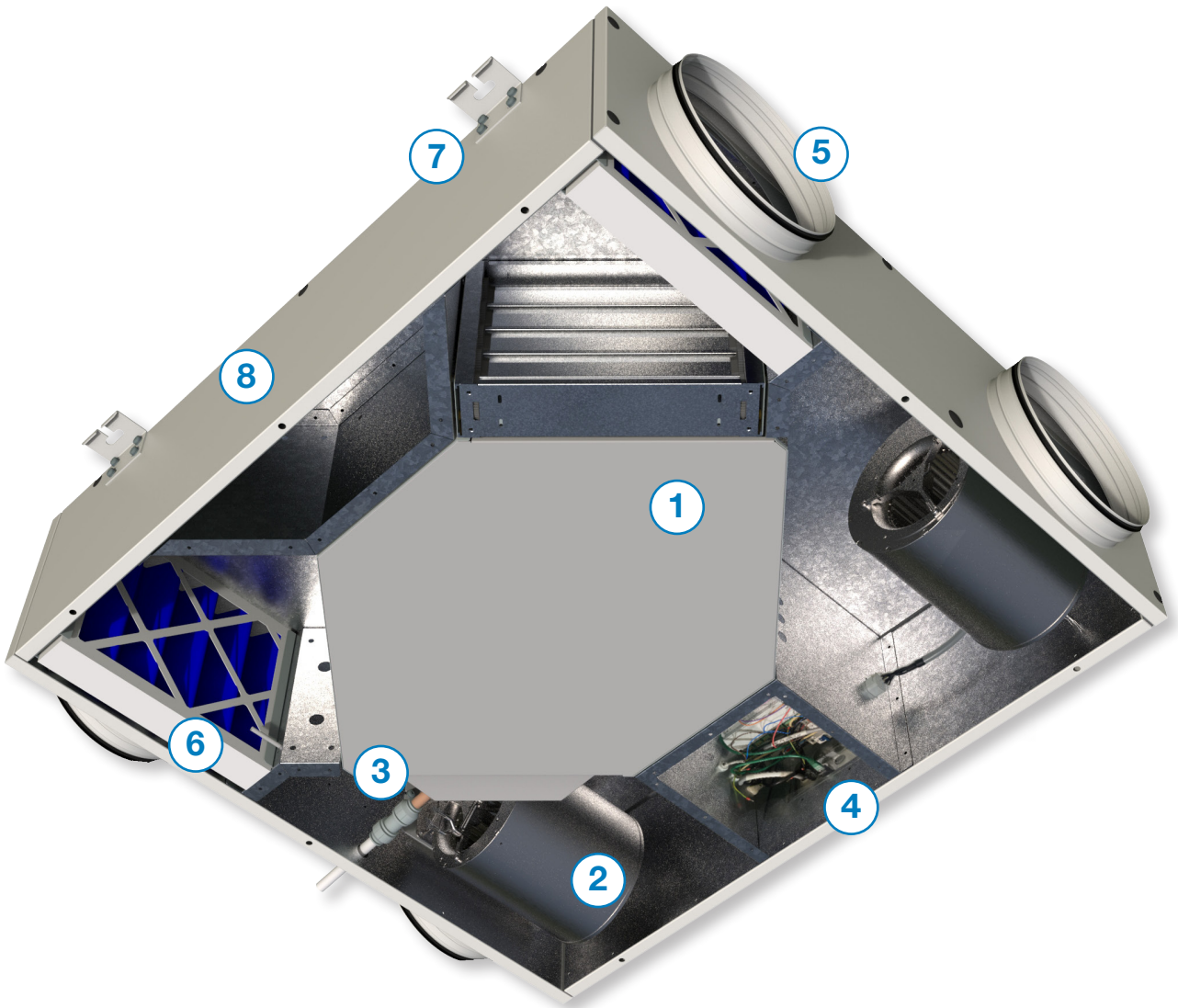



Ecovent® mini

Ecovent® has been recognised as the leading brand in heat recovery air handling units for over 30 years.

Compact yet packed with impressive features, the Ecovent mini is specifically crafted to meet the rigorous standards of modern building design. With its low height profile and enhanced capacity of up to 180 l/s, this range is the obvious choice, offering a combination of low Specific Fan Power and a highly efficient heat exchanger.

Ideal for a wide range of applications such as offices, schools, hotels, and retail establishments, the Ecovent mini range is designed to accommodate challenging installations. Now available in three different sizes, with bottom access, its compact design makes it perfect for ceiling void and plantroom locations. With various control options available, there's an Ecovent unit that will perfectly suit your needs.



 Prewired/Fitted Controls	 Demand Ventilation	 Case Construction	 Filters	 Air Quality	 Thyristor Heater
 Energy Efficient Fans	 Speed Control	 Plug & Play	 Humidity	 Temperature	 Heat Recovery

Energy Saving

Intelligent controls enhance performance whilst saving energy and money.

Ecovent® mini Features and Benefits

Energy Saving

Meet regulations, minimise noise and maximise performance.

Energy saving packages combine intelligent controls technology, products and services.

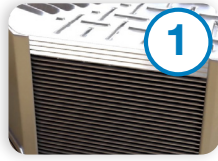

Premium Efficiency Heat Recovery

Using the latest Computational Fluid Dynamics simulations, the counterflow plate heat exchangers in Ecovent mini units have been designed to optimise airflow. This enables a true rate of heat transfer, giving efficiencies of up to 90% to BS EN 308:2022 specification and exceeding ErP requirements. The Ecovent mini range also achieves zero cross contamination of moisture, smells or fumes.



Energy Efficient

Energy efficient units with low SFPs to help achieve Building Regulations and other technical guides. Units are fully tested to BS EN ISO 5801:2017 (airside performance).



Noise Reduction

Independently tested to BS EN ISO 3744:2010, units can help meet acoustic requirements for sensitive applications including BB93 (School Acoustics).

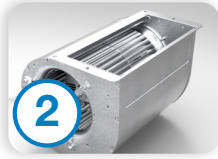

High Performance Fans

EC fans offering maximum efficiency, minimum energy consumption. Fully controllable and ErP2015 compliant.



Condensate Management

In certain conditions the unit may produce condensate. A standard drain pan is included, and various management solutions are offered, including pumps and sensors.

Simple Installation and Maintenance

Simple connection and pre-installed features save onsite costs and reduce lead times. Carefully designed maintenance features minimise downtime and total cost of ownership.

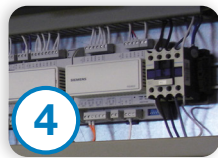

Pre-wired Controls

Energy saving packages combine intelligent technologies. The unit is pre-wired to an integral controls package to reduce onsite wiring requirements.

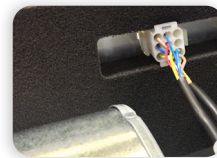

'Plug & Play' Fans

Fans are fitted with a quick change plug connector for easy maintenance. The fans feature EC motors and are balanced to G 2.5 / G 6.3 according to ISO 21940-11.

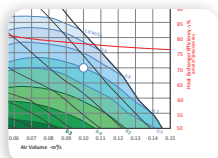

Airflow Commissioning

Volumes for supply or extract can be adjusted at the user interface, allowing more control of demand ventilation and night set back volume.



Duct Connections

Easy duct connections suitable for quick on site ductwork connection ensures an efficient fit whilst minimising potential noise breakout.

Versatile Options

Versatile location, handing and access options meet the widest range of project requirements

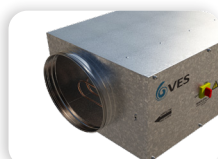

Heating Options

Duct mounted EHB and LPHW Coil modules are available for direct connection to the unit spigot outlets. Heaters are designed to suit a range of conditions and systems.



Filter Options

Filters are pleated media as standard, to BS EN ISO 16890 classification Coarse 65% (G4 EN 779:2012), with optional supply filters to ePM1 55% (F7 EN 779:2012).

Robust Construction

Excellent build quality ensures minimal noise breakout, low SFPs and airtight performance

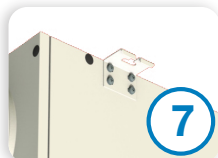

Case Construction

The unit is constructed from double skinned galvanised sheet steel panels with mineral wool slab infill, incorporating mounting brackets compatible with drop-rod systems.



Finish

Units are supplied painted white to RAL 9010 as standard. Bespoke casework colours and non-painted galvanised finishes are also available.

BlueSense Energy Saving Package

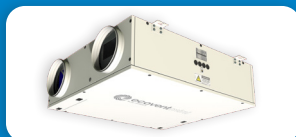

Ecovent® mini with integral controls



EC fan with full control



Sensor options



The sign of energy saving products, services and expertise

Selection data

Ecovent mini EVCM174

Performance

$$\text{SFP} \frac{\text{Watts/litres/second}}{\text{second}} = \frac{\text{Electrical input power (Watts)}}{\text{Air volume flow rate (litres/second)}}$$

Note: SFP figures quoted at voltages tested in accordance with BS EN ISO 5801:2017 for each of the two fans.

Nominal working conditions: 0.075 m³/s (75 l/s)
75 Pa approx = 97 W = 1.38 W/l/s
(Unit SFP, balanced airflow)

Heat exchanger efficiency is calculated based upon EAT -5 °C and RAT +20 °C.
The fan performance is calculated using standard G4 filters (BS EN ISO 16890 Coarse 65%).

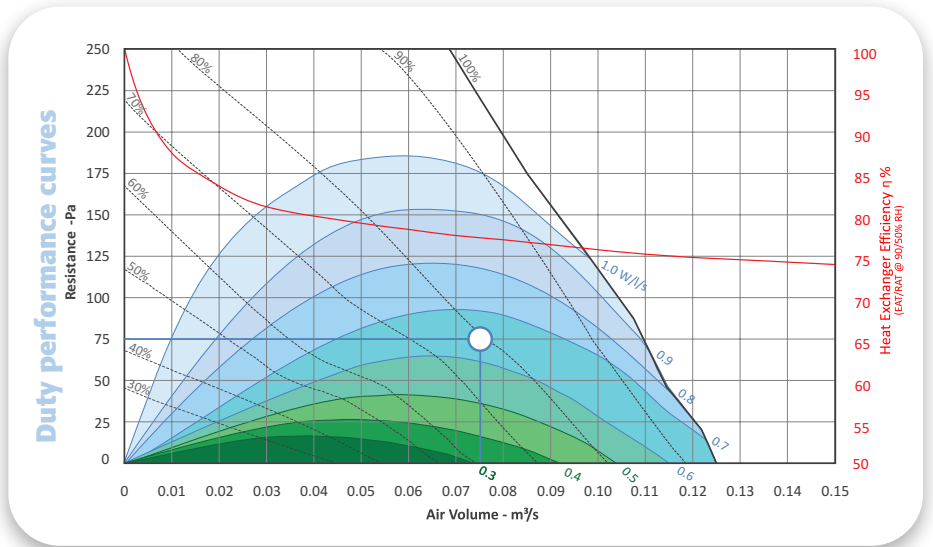

Size	Phase	Motor Size	Voltage	Fan Speed	FLC	Speed Control
EVCM174-1	1 Phase	0.100 kW	230 VAC	1410 rpm	0.83 A	EC

Acoustic data

Fan Speed	Sound Power Levels	Frequency Hz								Casing Radiated			
		63	125	250	500	1k	2k	4k	8k	NR@1m	NR@3m	dBA@1m	dBA@3m
100%	Casing Radiated	72	69	59	50	45	40	37	34	39	30	43	35
	Intake (ODA/ETA)	74	71	68	60	60	58	52	43				
	Outlet (SUP/EHA)	83	78	73	73	73	74	70	66				
80%	Casing Radiated	68	64	53	45	40	33	30	28	33	24	37	30
	Intake (ODA/ETA)	70	66	62	55	56	52	45	34				
	Outlet (SUP/EHA)	76	73	67	67	68	67	62	57				
60%	Casing Radiated	62	57	47	39	35	26	25	25	25	17	31	24
	Intake (ODA/ETA)	65	62	56	50	51	46	37	42				
	Outlet (SUP/EHA)	69	68	62	62	63	61	55	48				
40%	Casing Radiated	57	51	41	34	29	23	24	25	19	11	26	18
	Intake (ODA/ETA)	60	55	49	45	44	38	27	15				
	Outlet (SUP/EHA)	64	61	56	57	57	54	46	38				

Sound Spectrum dB re 10⁻¹² W pWL. Units are independently tested at ISVR in accordance with BS EN ISO 3744:2010

Unit dimensions

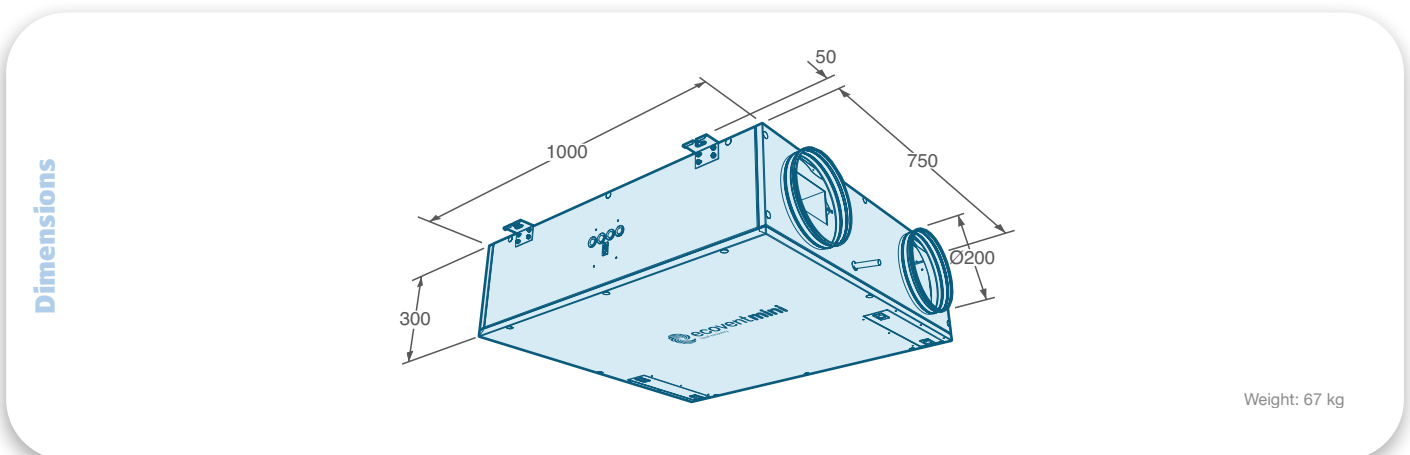

Note: Data for design guidance only. Detailed information is available upon request.

Selection data

Ecovent mini EVCM274

Performance

$$\text{SFP} \frac{\text{Watts/litres/second}}{\text{second}} = \frac{\text{Electrical input power (Watts)}}{\text{Air volume flow rate (litres/second)}}$$

Note: SFP figures quoted at voltages tested in accordance with BS EN ISO 5801:2017 for each of the two fans.

Nominal working conditions: 0.100 m³/s (100 l/s)
100 Pa approx = 139 W = 1.39 W/l/s
(Unit SFP, balanced airflow)

Heat exchanger efficiency is calculated based upon EAT -5 °C and RAT +20 °C.
The fan performance is calculated using standard G4 filters (BS EN ISO 16890 Coarse 65%).

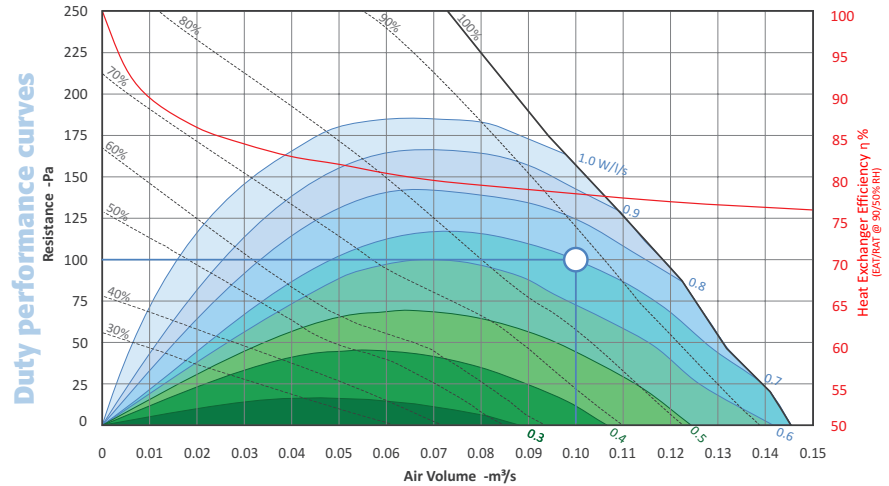

Size	Phase	Motor Size	Voltage	Fan Speed	FLC	Speed Control
EVCM274-1	1 Phase	0.100 kW	230 VAC	1410 rpm	0.83 A	EC

Acoustic data

Fan Speed	Sound Power Levels	Frequency Hz								Casing Radiated			
		63	125	250	500	1k	2k	4k	8k	NR@1m	NR@3m	dBA@1m	dBA@3m
100%	Casing Radiated	73	70	62	50	47	45	40	39	39	31	44	37
	Intake (ODA/ETA)	74	71	68	60	60	58	52	43				
	Outlet (SUP/EHA)	83	78	73	73	73	74	70	66				
80%	Casing Radiated	68	65	58	44	41	37	33	31	35	27	39	32
	Intake (ODA/ETA)	70	66	62	55	56	52	45	34				
	Outlet (SUP/EHA)	76	73	67	67	68	67	62	57				
60%	Casing Radiated	63	59	52	38	35	30	27	26	29	21	34	26
	Intake (ODA/ETA)	65	62	56	50	51	46	37	42				
	Outlet (SUP/EHA)	69	68	62	62	63	61	55	48				
40%	Casing Radiated	58	53	44	33	29	25	24	25	20	12	27	19
	Intake (ODA/ETA)	60	55	49	45	44	38	27	15				
	Outlet (SUP/EHA)	64	61	56	57	57	54	46	38				

Sound Spectrum dB re 10⁻¹² W pWL. Units are independently tested at ISVR in accordance with BS EN ISO 3744:2010.

Unit dimensions

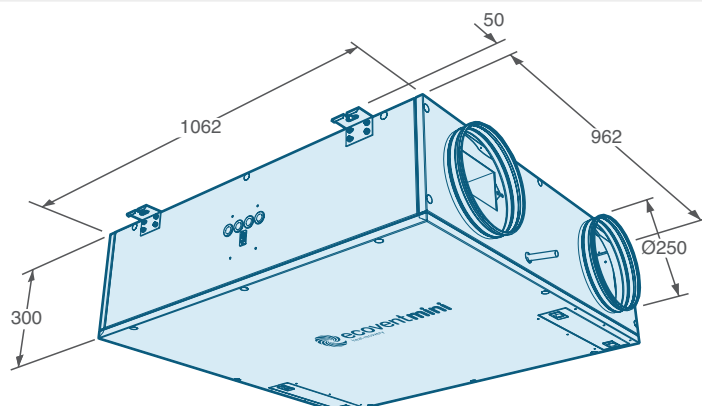

Weight: 82 kg

Selection data

Ecovent mini EVCM353

Performance

$$\text{SFP} \frac{\text{Watts/litres/second}}{\text{second}} = \frac{\text{Electrical input power (Watts)}}{\text{Air volume flow rate (litres/second)}}$$

Note: SFP figures quoted at voltages tested in accordance with BS EN ISO 5801:2017 for each of the two fans.

Nominal working conditions: 0.160 m³/s (160 l/s)
100 Pa approx = 206 W = 1.28 W/l/s
(Unit SFP, balanced airflow)

Heat exchanger efficiency is calculated based upon EAT -5 °C and RAT +20 °C.
The fan performance is calculated using standard G4 filters (BS EN ISO 16890 Coarse 65%).

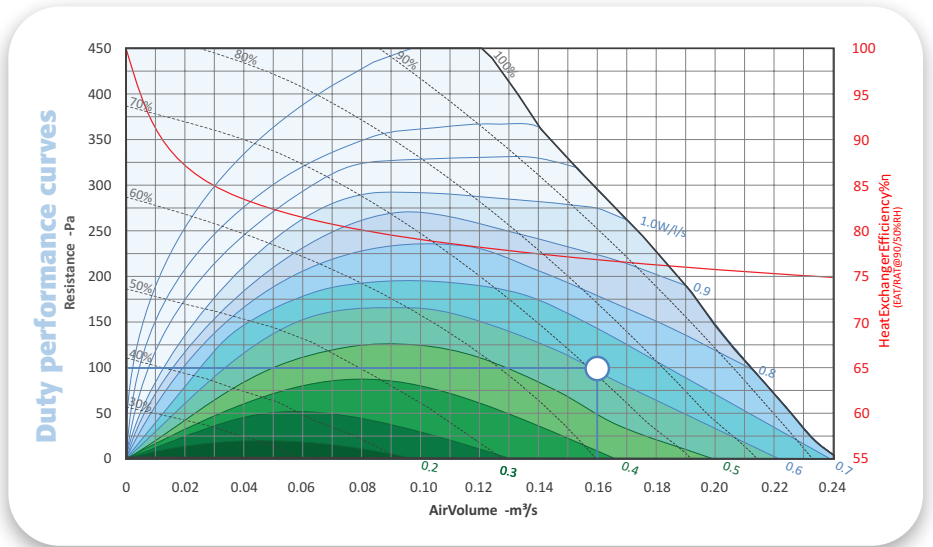

Size	Phase	Motor Size	Voltage	Fan Speed	FLC	Speed Control
EVCM353-1	1 Phase	0.170 kW	230 VAC	2860 rpm	1.75 A	EC

Acoustic data

Fan Speed	Sound Power Levels	Frequency Hz								Casing Radiated			
		63	125	250	500	1k	2k	4k	8k	NR@1m	NR@3m	dBA@1m	dBA@3m
100%	Casing Radiated	72	64	60	46	43	40	34	28	36	28	40	33
	Intake (ODA/ETA)	84 / 80	83 / 71	86 / 78	78 / 71	79 / 69	78 / 67	74 / 60	69 / 52				
	Outlet (SUP/EHA)	81 / 97	69 / 89	77 / 90	72 / 87	71 / 86	69 / 89	61 / 81	51 / 78				
80%	Casing Radiated	72	64	60	46	43	40	34	28	36	28	40	33
	Intake (ODA/ETA)	84 / 80	83 / 71	86 / 78	78 / 71	79 / 69	78 / 67	74 / 60	69 / 52				
	Outlet (SUP/EHA)	80 / 98	69 / 90	77 / 87	72 / 84	71 / 83	69 / 85	61 / 78	51 / 74				
60%	Casing Radiated	61	58	57	39	36	34	32	29	34	26	36	28
	Intake (ODA/ETA)	73 / 69	77 / 65	81 / 72	71 / 64	72 / 63	71 / 60	66 / 51	60 / 44				
	Outlet (SUP/EHA)	68 / 88	63 / 80	70 / 81	65 / 74	64 / 72	62 / 77	53 / 67	42 / 62				
40%	Casing Radiated	53	55	43	29	26	25	25	26	21	13	27	19
	Intake (ODA/ETA)	65 / 59	72 / 59	69 / 60	61 / 53	61 / 52	59 / 48	53 / 38	43 / 26				
	Outlet (SUP/EHA)	58 / 76	58 / 74	58 / 66	54 / 63	53 / 62	51 / 65	40 / 56	25 / 42				

Sound Spectrum dB re 10⁻¹² W pW/L. Units are independently tested at ISVR in accordance with BS EN ISO 3744:2010

Unit dimensions

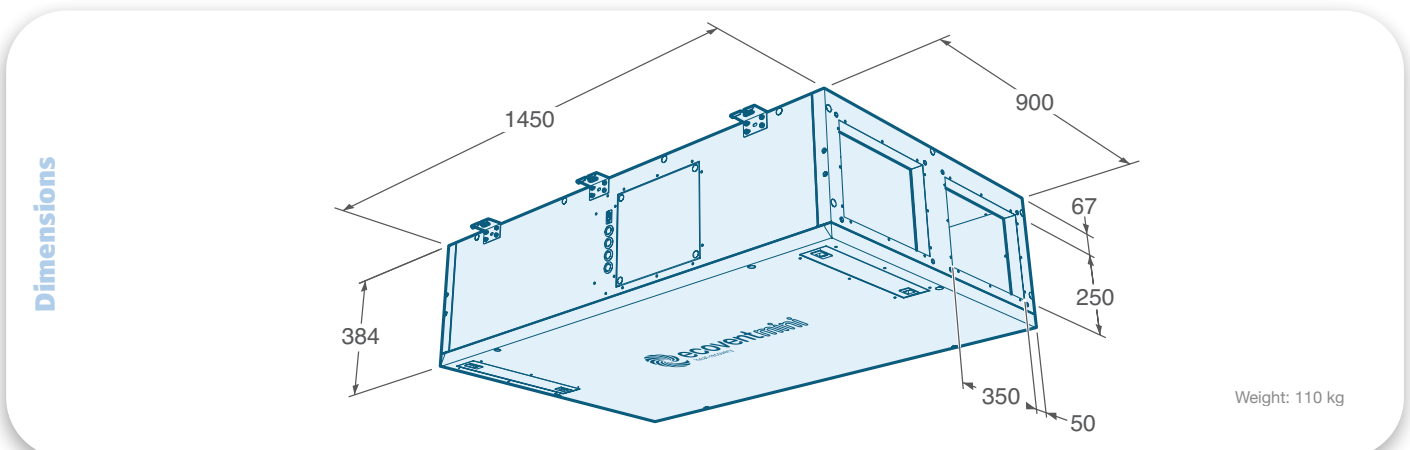

Note: Data for design guidance only. Detailed information is available upon request.

Ecovent® Silencers

Ecovent EVCMA1 & 2

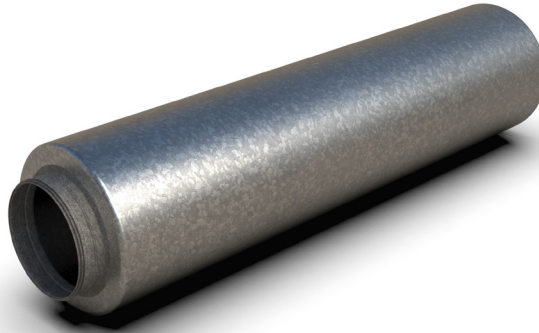

Performance

Notes:
Units are independently tested in accordance with BS EN ISO 3741:2010.

EVCMA2 silencers require a step-down adapter for direct fit to the unit. This is included where necessary.

Tolerances:
On flow rates: +/- 5%
On acoustic power and pressure: Levels: +/- 3 dB
By octave band: +/- 5 dB

Performance curves

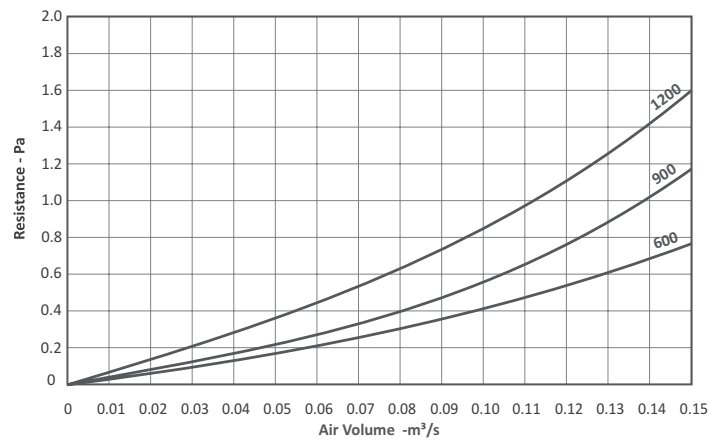

Acoustic data

Silencer Induct Losses	Frequency Hz							
	63	125	250	500	1k	2k	4k	8k
EVCMA100/CS/0600	-1	-3	-6	-11	-25	-20	-11	-12
EVCMA100/CS/0900	-1	-4	-8	-13	-27	-26	-13	-12
EVCMA100/CS/1200	-2	-5	-14	-27	-46	-36	-21	-13
EVCMA200/CS/0600	-1	-3	-6	-11	-25	-20	-11	-12
EVCMA200/CS/0900	-1	-4	-8	-13	-27	-26	-13	-12
EVCMA200/CS/1200	-2	-5	-14	-27	-46	-36	-21	-13

Sound Spectrum dB re 10⁻¹² W pWL. Units are independently tested in accordance with BS EN ISO 7235:2003.

Unit dimensions

Dimensions

Silencers	Dimensions mm			Weight kg
	A	ØB	ØC	
EVCMA100/CS/0600	600	300	200	7.0
EVCMA100/CS/0900	900	300	200	10.0
EVCMA100/CS/1200	1200	300	200	11.1
EVCMA200/CS/0600	600	300	250*	7.0
EVCMA200/CS/0900	900	300	250*	10.0
EVCMA200/CS/1200	1200	300	250*	11.1

* adapters required

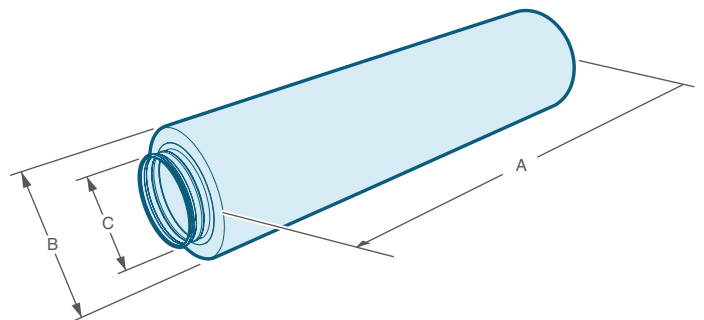

Note: Data for design guidance only. Detailed information is available upon request.

Ecovent® Silencers

Ecovent EVCMA3

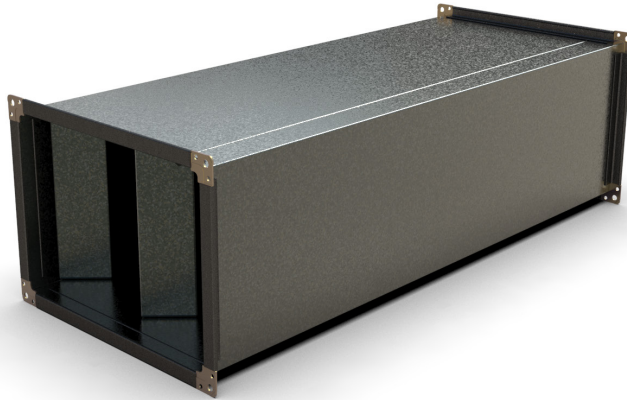

Performance

Notes:
Units are independently tested in accordance with BS EN ISO 3741:2010.

EVCMA3 silencers are fitted with a 20mm flange.

Tolerances:
On flow rates: +/- 5%
On acoustic power and pressure: Levels: +/- 3 dB
By octave band: +/- 5 dB

Performance curves

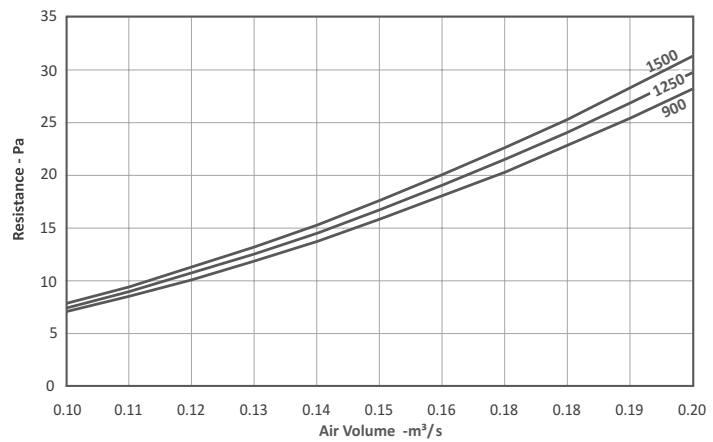

Acoustic data

Silencer In duct Losses	Frequency Hz							
	63	125	250	500	1k	2k	4k	8k
EVCMA300/SS/0950	-5	-8	-16	-33	-37	-28	-20	-16
EVCMA300/SS/1250	-7	-10	-20	-40	-47	-36	-24	-18
EVCMA300/SS/1600	-9	-13	-25	-49	-55	-45	-28	-20

Sound Spectrum dB re 10⁻¹² W pW/L. Units are independently tested in accordance with BS EN ISO 7235:2003.

Unit dimensions

Dimensions

Silencers	Dimensions mm			Weight kg
	A	B	C	
EVCMA300/SS/0950	950	350	250	24.0
EVCMA300/SS/1250	1250	350	250	30.0
EVCMA300/SS/1600	1600	350	250	39.0

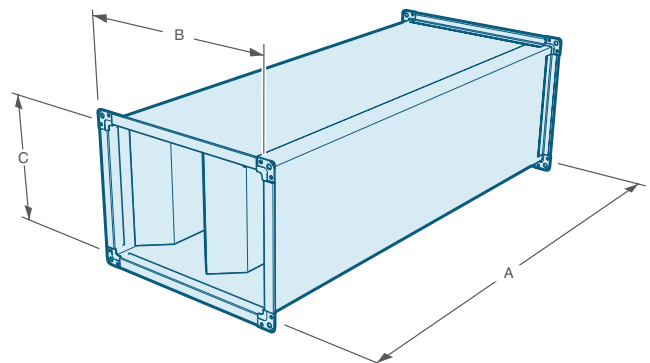

Note: Data for design guidance only. Detailed information is available upon request.

Ecovent® Duct mounted EHB

Ecovent EVCMEH1 & 2

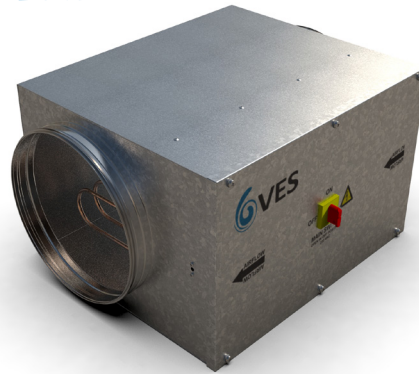

Performance

These heaters are designed to work with Ecovent mini units only, mounted directly to the unit or in-line with the adjacent ductwork. There are three sizes to match the appropriate unit, suitable for single phase supply as standard with three phase options available.

The integrated controls features a thyristor for modulating the temperature output, and an airflow pressure switch to shut off the heater in the event of airflow failure. The controls must be connected directly to the Ecovent mini unit for correct operation.

Recommended minimum velocity is 1.5 m/s. For selection points outside the range shown please contact VES for further information.

Duty performance

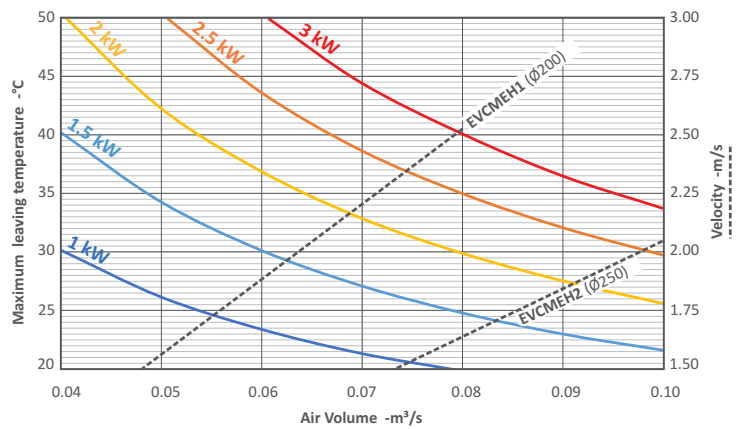

	Duty m³/s	Air on Temp °C	Max Air Off Temp °C	Maximum Output kW	1Φ Electric Heater
EVCMEH1	0.05	9.9	26.2	1.0	EVCMEH1/1KW/1X1
	0.06	9.8	30.1	1.5	EVCMEH1/1.5KW/1X1
	0.07	9.7	32.9	2.0	EVCMEH1/2KW/1X1
	0.08	9.6	29.9	2.0	EVCMEH1/2KW/1X1
EVCMEH2	0.07	9.7	32.9	2.0	EVCMEH2/2kW/1X1
	0.08	9.6	29.9	2.0	EVCMEH2/2kW/1X1
	0.09	9.5	32.1	2.5	EVCMEH2/2.5kW/1X1
	0.1	9.4	33.8	3.0	EVCMEH2/3kW/1X1

Air off temperature based upon entering air FAT -5 °C, RAT 12 °C, after the heat exchanger.
 Power = Air Volume x Constant x Temperature Rise kW = m³/s x 1.21 x ΔT °C

Unit dimensions

Dimensions

EHB	Dimensions mm				Weight kg
	A	B	C	D	
EVCMEH1/___	240	360	550	200	9
EVCMEH2/___	290	410	550	250	10

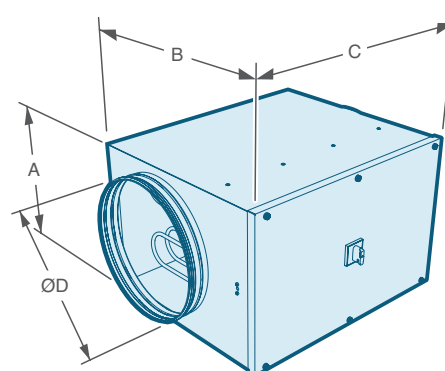

Ecovent® Duct mounted EHB

Ecovent EVCMEH3

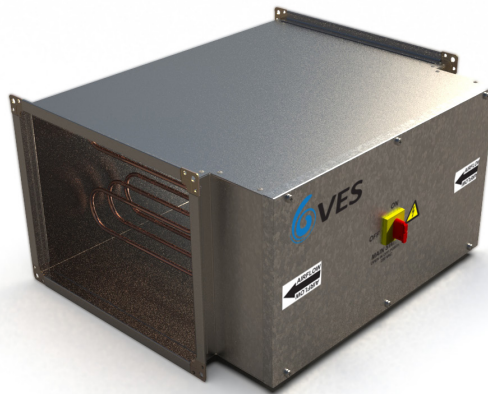

Performance

These heaters are designed to work with Ecovent mini units only, mounted directly to the unit or in-line with the adjacent ductwork. There are three sizes to match the appropriate unit, suitable for single phase supply as standard with three phase options available. The size 3 is fitted with a 20mm MEZ flange.

The integrated controls features a thyristor for modulating the temperature output, and an airflow pressure switch to shut off the heater in the event of airflow failure. The controls must be connected directly to the Ecovent mini unit for correct operation.

Recommended minimum velocity is 1.5 m/s. For selection points outside the range shown please contact VES for further information.

Duty performance

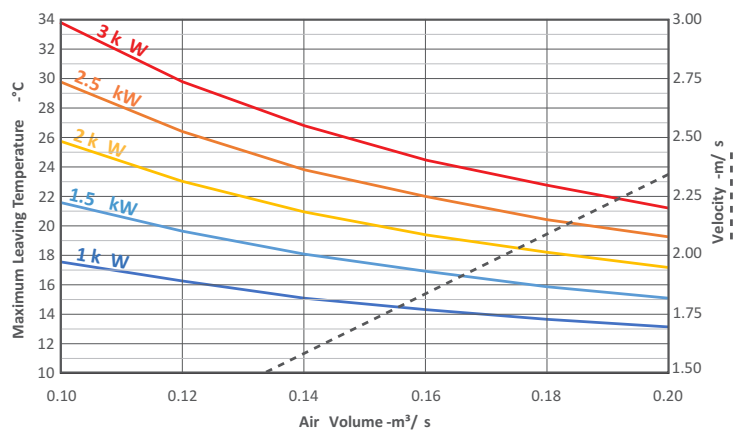

	Duty m³/s	Air on Temp °C	Max Air Off Temp °C	Maximum Output kW	1Φ Electric Heater
EVCMEH3	0.10	9.5	21.7	1.50	EVCMEH3/1.5KW/1X1
	0.12	9.5	23.1	2.00	EVCMEH3/2KW/1X1
	0.14	9.4	23.9	2.50	EVCMEH3/2.5KW/1X1
	0.16	9.3	22.0	2.50	EVCMEH3/2.5KW/1X1
	0.18	9.2	22.8	3.00	EVCMEH3/3KW/1X1
	0.20	9.1	21.3	3.00	EVCMEH3/3KW/1X1

Air off temperature based upon entering air FAT -5 °C, RAT 12 °C, after the heat exchanger.
 Power = Air Volume x Constant x Temperature Rise kW = m³/s x 1.21 x ΔT °C

Unit dimensions

EHB	Dimensions mm				Weight kg
	A	B	C	D	
EVCMEH3_	250	472	630	350	15

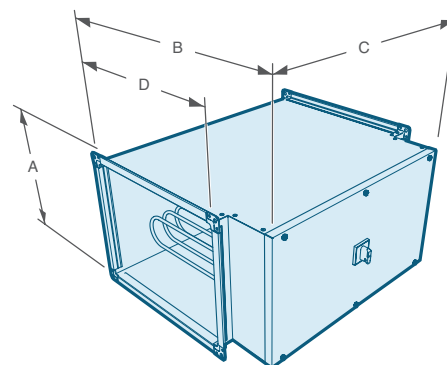

Ecovent® Duct mounted Coil

Ecovent EVCMHW1

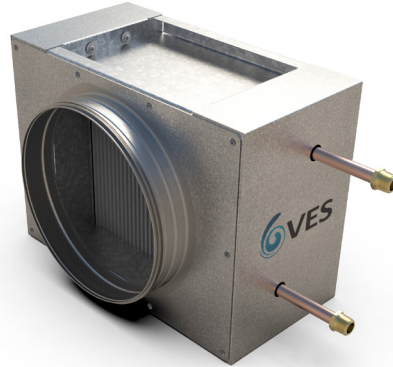

Performance

Performance curves

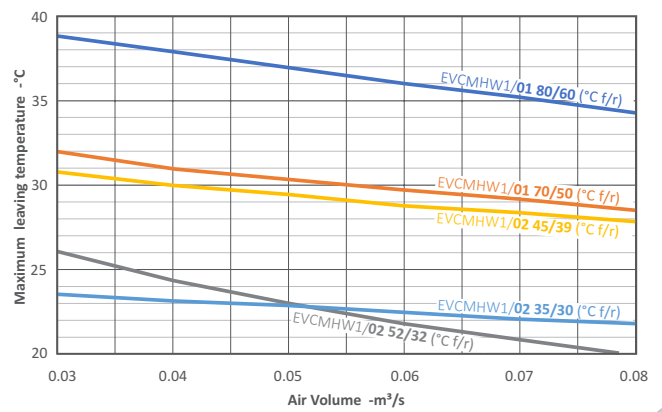
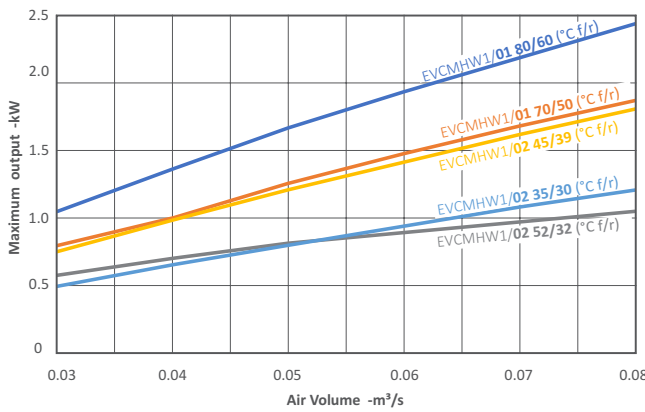

EVCMHW1/01	Flow/Return °C	Duty m³/s	Max Leaving Temperature °C	Max Output kW	Water Flow Rate l/s	Water Pressure Drop kPa	Air Pressure Drop Pa
	80/60	0.04	0.04	37.90	1.37	0.017	3.00
0.06		0.06	36.00	1.94	0.024	3.00	9
0.08		0.08	34.30	2.45	0.030	3.00	15
70/50	0.04	0.04	30.40	1.01	0.012	3.00	5
	0.06	0.06	29.70	1.48	0.018	3.00	9
	0.08	0.08	28.50	1.88	0.023	3.00	15

EVCMHW1/02	Flow/Return °C	Duty m³/s	Max Leaving Temperature °C	Max Output kW	Water Flow Rate l/s	Water Pressure Drop kPa	Air Pressure Drop Pa
	52/32	0.04	0.04	24.30	0.71	0.009	3.00
0.06		0.06	21.70	0.90	0.011	3.00	15
0.08		0.08	19.90	1.05	0.013	3.00	25
45/39	0.04	0.04	30.00	0.99	0.040	3.00	7
	0.06	0.06	28.80	1.42	0.057	3.00	15
	0.08	0.08	27.80	1.81	0.073	4.00	25
35/30	0.04	0.04	23.10	0.66	0.032	3.00	7
	0.06	0.06	22.40	0.95	0.046	3.00	15
	0.08	0.08	21.70	1.22	0.059	3.00	25

Air off temperature based upon entering air FAT -5 °C, RAT 12 °C, taken after the heat exchanger.
Coil construction copper tubes, aluminium fins, coil connections ½" BSP.
Bespoke coils to suit alternative flow and return temperatures available upon request.

Unit dimensions

Dimensions

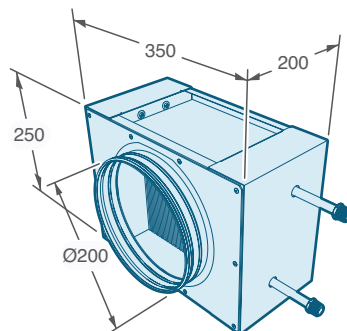

Weight: 8 kg (wet, approx)

Ecovent® Duct mounted Coil

Ecovent EVCMHW2

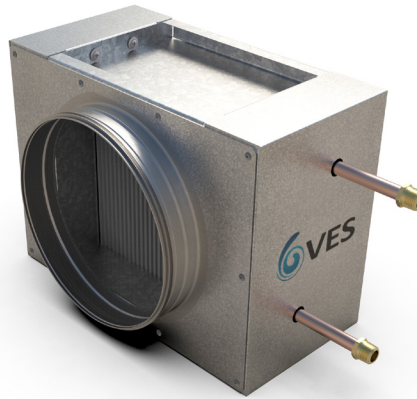

Performance

Performance curves

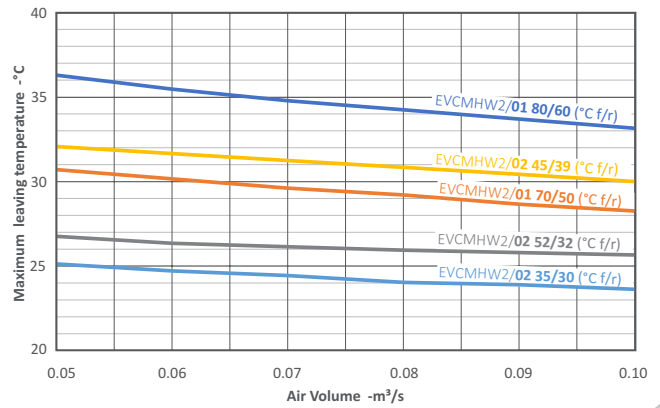
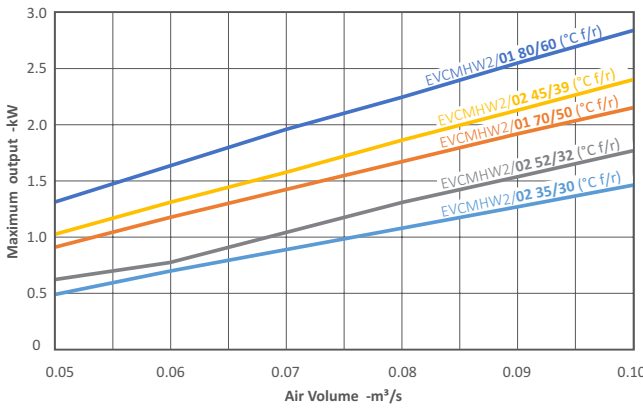

EVCMHW2/01	Flow/Return °C	Duty m³/s	Max Leaving Temperature °C	Max Output kW	Water Flow Rate l/s	Water Pressure Drop kPa	Air Pressure Drop Pa
	80/60	0.06	35.50	1.87	0.023	3.00	4
	0.08	34.20	2.38	0.029	3.00	5	
	0.10	33.10	2.87	0.035	3.00	7	
	70/50	0.06	30.10	1.48	0.018	3.00	4
	0.08	29.20	1.90	0.023	3.00	5	
	0.10	28.30	2.29	0.028	3.00	7	

Air off temperature based upon entering air FAT -5 °C, RAT 12 °C, taken after the heat exchanger.
Coil construction copper tubes, aluminium fins, coil connections ½" BSP.
Bespoke coils to suit alternative flow and return temperatures available upon request.

EVCMHW2/02	Flow/Return °C	Duty m³/s	Max Leaving Temperature °C	Max Output kW	Water Flow Rate l/s	Water Pressure Drop kPa	Air Pressure Drop Pa
	52/32	0.06	26.40	1.15	0.014	3.00	6
0.08		26.00	1.59	0.019	3.00	10	
0.10		25.70	1.97	0.024	3.00	15	
45/39	0.06	31.60	1.59	0.064	4.40	6	
	0.08	30.80	2.05	0.083	7.10	10	
	0.10	30.00	2.50	0.101	10.30	15	
35/30	0.06	24.70	1.08	0.052	3.10	6	
	0.08	24.10	1.41	0.068	5.00	10	
	0.10	23.60	1.72	0.083	7.30	15	

Unit dimensions

Dimensions

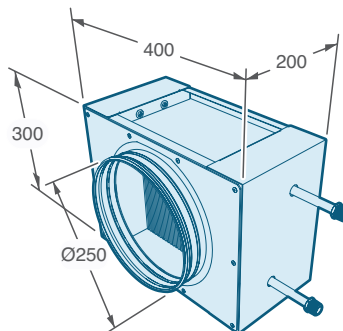

Weight: 10 kg (wet, approx)

Ecovent® Duct mounted Coil

Ecovent EVCMHW3

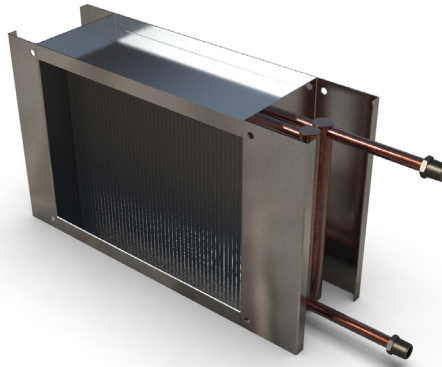

Performance

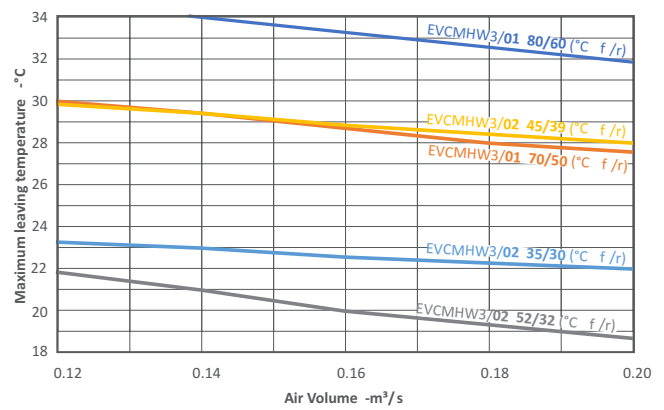
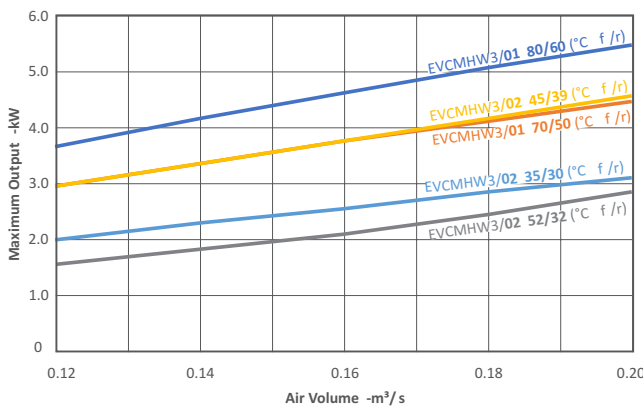

EVCMHW3/01	Flow/Return °C	Duty m³/s	Max Leaving Temperature °C	Max Output kW	Water Flow Rate l/s	Water Pressure Drop kPa	Air Pressure Drop Pa
	80/60	0.14	33.90	4.16	0.051	3.00	7
		0.16	33.20	4.63	0.056	3.70	9
		0.18	32.50	5.07	0.062	4.40	11
	70/50	0.14	29.30	3.37	0.041	3.00	7
		0.16	28.60	3.75	0.046	3.00	9
		0.18	28.00	4.12	0.050	3.00	11

EVCMHW3/02	Flow/Return °C	Duty m³/s	Max Leaving Temperature °C	Max Output kW	Water Flow Rate l/s	Water Pressure Drop kPa	Air Pressure Drop Pa
	52/32	0.14	20.90	1.94	0.023	3.00	15
		0.16	20.00	2.08	0.025	3.00	18
		0.18	19.30	2.20	0.027	3.00	23
	45/39	0.14	29.30	3.37	0.136	4.40	15
		0.16	28.80	3.78	0.152	5.40	19
		0.18	28.30	4.18	0.168	6.40	24
	35/30	0.14	22.90	2.28	0.110	3.10	15
		0.16	22.50	2.57	0.123	3.80	19
		0.18	22.20	2.84	0.137	4.50	23

Air off temperature based upon entering air FAT -5 °C, RAT 12 °C, taken after the heat exchanger.
Coil construction copper tubes, aluminium fins, coil connections ½" BSP.
Bespoke coils to suit alternative flow and return temperatures available upon request.

Unit dimensions

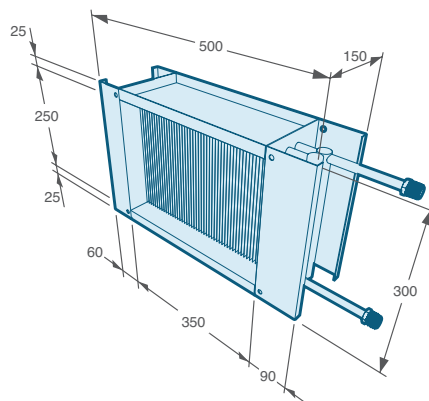

Weight: 8 kg (wet, approx)

Control packages for performance and efficiency



Save energy and costs with BlueSense Controls

Demand ventilation solutions













BlueSense philosophy combines intelligent control technologies with energy saving products, services and engineering expertise. BlueSense helps meet energy reduction commitments by optimising equipment performance, improving energy efficiency, saving money and increasing equipment life expectancy.

BlueSense can be applied to a variety of projects and applications, providing efficient solutions whilst supporting design for best practice and sustainability.



BlueSense Features

- ▶ Inbuilt intelligent controls technology
- ▶ Optimises performance and efficiency
- ▶ Demand ventilation control improves air quality, reducing energy consumption and lowering operating costs
- ▶ CO₂ and VOC sensing technology with energy efficient speed control
- ▶ Extending equipment life expectancy and reducing maintenance
- ▶ Short term payback on capital expenditure
- ▶ Extended warranty



 Prewired/Fitted Controls	 Demand Ventilation	 Case Construction	 Filters	 Air Quality	 Thyristor Heater
 Energy Efficient Fans	 Speed Control	 Plug & Play	 Humidity	 Temperature	 Heat Recovery

Ecovent mini BlueSense

All products in the Ecovent range can form part of a BlueSense energy saving package. Specify BlueSense to ensure units are optimised with pre-wired controls, energy efficient speed controller and air quality sensor.

All of these work in unison, reducing energy consumption and saving money.

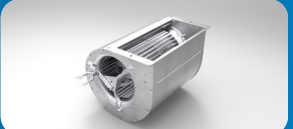
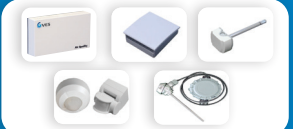
A BlueSense Example

	+		+		=	
Ecovent® mini with integral controls		EC fan with full control		Sensor options		The sign of energy saving products, services and expertise

Ecovent® mini Controls - Extended Features CPEVCM

The Ecovent **mini** unit with integrated controls is specifically designed for use in heat recovery applications. The CPEVCM control system is supplied fully integrated into an Ecovent **mini** air handling unit to reduce installation time and costs, and can be supplied as a loose panel for installation by others if required.

Features

- Designed, manufactured and supported by VES engineers
- Default settings for “out of the box” operation and to minimise commissioning time
- Versatile user interface and open protocol integration option
- Easily identified field terminals to assist installation and maintenance
- Extensive parameter adjustment to optimise installation and further improve system efficiency
- Optional energy monitoring providing real time energy consumption and efficiency information

Specification for CPEVCM for Heat Recovery Applications

Features	CPEVCM
Fitted and pre-wired within Ecovent mini or traditional loose panel options	✓
Heat recovery damper modulation, free heating and cooling optimisation	✓
Modulating electric heating control option	✓
Frost protection and heating demand output for water coils option	✓
Temperature philosophy; supply, return or return + supply limits	✓
7 day time clock	○
Condensate pump control	○
Demand ventilation; Air Quality, constant pressure	○
Filter dirty indication; inputs for DP switches	✓
Fan run-on and safety interlocks	✓
Remote start / stop via removable link	✓
Common trip indication	✓
Fire alarm shutdown, 24 VDC	○
Inlet and return damper	○
Remote user interface, full function	✓
Remote user interface, full function touch screen	○
Energy monitoring with real time display	○
Heat recovery efficiency with real time display	○
Integration by Modbus over RS485 open protocol or ethernet BACnet MS/TP	✓
Integration by BACnet/IP open protocol	○
Bespoke to suit requirement	○
BlueSense - Energy Saving Package	✓
Energy efficient speed control	✓
Demand Control	✓
Post installation Commissioning	○

○ = Option



BlueSense includes an Extended Warranty

- 3 years with BlueSense packages
- 5 years with BlueSense package and Post Installation Commissioning

Please quote BlueSense with your order or contact our specialist sales team for further information. Call +44 (0)2380 46 11 50 or Email sales@ves.co.uk

Product Specification

Ecovent® mini (EVCM) Compact Heat Recovery Units

1.1. General

A. Provide a heat recovery air handling unit to meet the performance and configuration as indicated in the schedule and detail drawings. The heat recovery air handling unit shall be tested to BS EN ISO 5801:2017 and shall be of the Ecovent type as manufactured by VES Andover Ltd, a company accredited with BS EN ISO 9001:2015.

1.2. Unit Construction

- A. The unit shall be provided pre-assembled comprising double skinned galvanised sheet steel panels, supply and extract centrifugal fans with direct drive motor, supply and extract G4 pleated panel filters, and plate heat exchanger with drain pan.
- B. The construction shall be tested in accordance with BS EN 1886:2007.
- C. The unit shall be supplied in one section.
- D. The unit shall be available in plantroom construction as indicated in the schedule and detail drawings.
- E. The unit shall be fitted with a heat exchanger bypass duct, incorporating a face and bypass damper to allow heating / cooling recovery.
- F. The units shall have either circular safe-fit spigots compatible with spiral ductwork, or rectangular connections compatible with 20mm MEZ flange connections as indicated in the schedule and detail drawings.
- G. The unit casework shall incorporate high quality rubber gasket seals on service doors and panels.
- H. Access for maintenance shall be via a removable panel, allowing access for the cleaning or removal of internal components as indicated in the detail drawings. The filters shall be bottom withdrawal as standard.
- I. Flat plantroom casework shall incorporate mounting brackets compatible with drop-rod systems.
- J. The unit shall be supplied in the configuration: flat, plantroom. Access and handing options shall be as indicated in the schedule and detail drawings.

1.3. Fans

- A. The fan impellers shall be statically and dynamically balanced to G 2.5 / G 6.3 according to ISO 21940-11:2016.
- B. The fan impellers shall be mated with aerodynamic bell inlet eyes for high efficiency and low noise generation.
- C. The fan impellers shall be supplied in natural uncoated finish as standard.

1.4. Motors

- A. The fans shall incorporate external rotor motors to insulation class F, IP4X environmental protection rating and shall be supplied with thermal protection cut-out as standard.

1.5. Plate Heat Exchanger

- A. The unit shall be supplied with a Counterflow heat exchanger tested in accordance with BS EN 308:2022.
- B. The heat exchanger shall be to an efficiency of at least 75% (-5/+20 °C, 90/50% RH).
- C. The plate heat exchanger matrix shall be aerodynamically designed, with built-in spacers ensuring a constant plate separation.

1.6. Drain Pan

- A. The unit shall include a built-in condensate drain pan as standard.

1.7. Filtration

- A. The filters shall be pleated filter media as standard, with rigid wax treated cardboard moisture resistant frame.
- B. Filters shall be to BS EN ISO 16890 classification Coarse 65% (G4 EN 779:2012) as standard, grade as indicated in the schedule and detail drawings.

1.8 Heating

- A. The unit shall come with no heating as standard. Options for duct mounted ancillary heating are available as indicated in the schedule.

Product Specification continued

1.9. Operation Environment

A. The unit shall be designed to operate in ambient temperatures from -20 °C up to +40 °C and to run continuously at up to 90% relative humidity level.

2.0. Controls

A. The unit shall be fitted with an EC fan speed control system with min/max speed and 0-10 VDC BMS control

B Temperature sensor shall be fitted as standard.

C. Fitted controls shall be positioned as indicated in the schedule and detail drawings.

D. Controls shall be supplied with internally mounted circuit breakers.

E. Fitted controls shall be supplied with a supply air duct sensor to be fitted by others onsite as indicated in the schedule.

F. Fitted controls shall be fully pre-wired to internal components.

2.1. Ancillaries

A. The unit shall be fully compatible with a standard range of spigot mounted silencers. The silencers shall be suitable for direct mounting to the unit.

B. The silencer shall be a rigidly constructed double skinned galvanised sheet steel case lined with resin bonded mineral wool.

C. The silencer casework shall be provided naturally finished in high quality galvanised steel as standard. External powder coat shall be available as indicated in the schedule. Colour shall be in accordance with schedule.

D. The units shall be available with duct mounted hot water or electric element heating as indicated in the schedule and detail drawings, suitable for direct fitting to the end of the unit.

E. The duct mounted hot water heater battery shall be of copper tube, aluminium fin block construction, with galvanised sheet steel casework.

F. The duct mounted hot water heater battery shall be available with alternative fin coatings by special order, as indicated in the schedule.

G. The duct mounted electric heater battery shall be suitable for single-phase supply and compatible with thyristor control as indicated in the schedule and detail drawings.

H. The duct mounted electric heater battery shall consist of an element array, sized to suit the steps and phases as indicated in the schedule and detail drawings. The elements shall consist of a tubular incoloy shroud containing compressed magnesium oxide powder packed around a nickel chromium resistance wire. The element array shall be evenly spread across the open area of the duct.

I. Where multiple elements are required to achieve the steps and phases as indicated in the schedule, elements shall be linked by copper busbar or terminated with electrical connectors.

J. The duct mounted electric heater battery shall be fitted as standard with a thermal safety cut out, adjustable from +40 °C to +80 °C, with automatic reset.

K. All duct mounted electric heaters shall be 1500 V flash tested, and resistance tested for correct component assembly. Test certificates shall be available on request.

ecovent [®] Counterflow						Case Construction				Options				Ancillaries Examples	
Product	HREC Type	Unit Size	Fan Type	Fan Size	Phase	Unit Config	Heating	Infill	Handing	Main Filter	Control Panel Section	Condensate Pump	Colour	Name	Part No.
EV	CM	1	7	4	-1	/FP	[null]	/DS	/RB	/G4	/ISC	/PP	[null]	Duct Mounted LPHW Coil	EVCMHW1/01
		2	7	4	-1				/LB	/F7	/CPSC		/R9010LT	Duct Mounted EHB	EVCMEH2/3kW/1X3
		3	5	3	-1									Valve & Acuator Kit	EVCMCWKT100
														Silencer	EVCMA300/1250

Product EV (ecovent)	Unit Config /FP= Flat Plantroom	Heating [null] =No Heating	Infill DS = Double Skinned	Handing Plantroom /RB=Right Bottom Flat /LB=Left Bottom	Main Filter /G4 /F7	Control Panel Section /CPSC=Control Panel and built in Speed Controller	Condensate Pump /PP=internally fitted condensate pump	Colour NULL = Galvanised /R9010LT= RAL9010 in leatherette finish
--------------------------------	---	--------------------------------------	--------------------------------------	--	----------------------------------	---	--	--

Example Codes

Plantroom EVCM174-1/FP/RB/G4/CPSC/R9010LT

Other products and services from the complete range of VES HVAC solutions

Air Handling Units

- ▶ Supply and extract, combined or separate
- ▶ Heat recovery including crossflow plate heat exchangers, thermal wheels and run-around coils
- ▶ Plantroom or weatherproof, flat or stacked
- ▶ Fitted silencers, inverters and controls
- ▶ Matching DX condensing units
- ▶ Various case constructions including EN 1886 certified units

Duct Fans

- ▶ In-line centrifugal, with forward or backward curved impellers
- ▶ Round, axial and mixed flow fans
- ▶ Fitted silencers available on all units
- ▶ Manual and automatic speed controllers available

Twin Fans

- ▶ For ceiling void, plantroom and weatherproof
- ▶ Many models and configurations
- ▶ Fitted auto-changeover system

Hybrid Units

- ▶ Natural ventilation enhanced by a low power fan
- ▶ Utilises a combination of automatic mechanical ventilation and manually operated windows to achieve classroom comfort conditions
- ▶ Simple user interface with indication of operating mode
- ▶ Slimline, lightweight construction, saving space and easing installation
- ▶ Available in a range of sizes with the ability to add heating coils when required

Roof Extract Units

- ▶ Three ranges for volume and pressure
- ▶ Curb and soaker sheet bases

Wall and Ceiling Fans

- ▶ All types for commercial, industrial and domestic premises

Kitchen Hood Extract Fans

- ▶ Heavy duty high temperature fans for hot greasy air
- ▶ Motors out of airstream
- ▶ Single inlet fans, in-line and vertical jet roof units

Control Panels

- ▶ Off the shelf and built to order panels
- ▶ Air quality sensors and energy savers
- ▶ Intelligent control software
- ▶ A range of remotes including touch screen

Noise Control

- ▶ Matching silencers available for all ventilation products
- ▶ Silencers designed to meet noise criteria
- ▶ Cleanable silencers
- ▶ Weatherproof silencers

Specialist Site Services

- ▶ Plant refurbishment
- ▶ Energy saving upgrades
- ▶ Noise reduction
- ▶ Site surveys
- ▶ Kitchen ventilation
- ▶ AHU flat pack installation
- ▶ Maintenance
- ▶ Spares

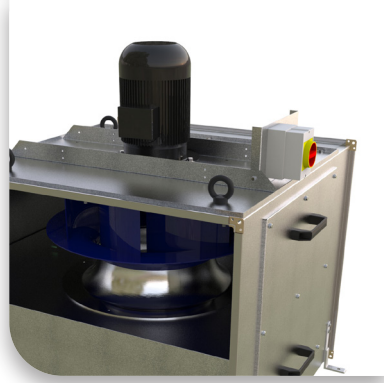
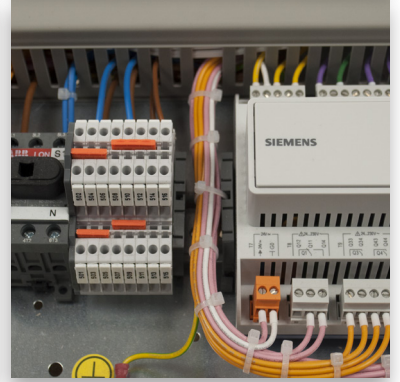
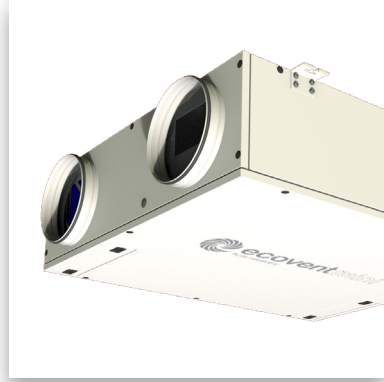
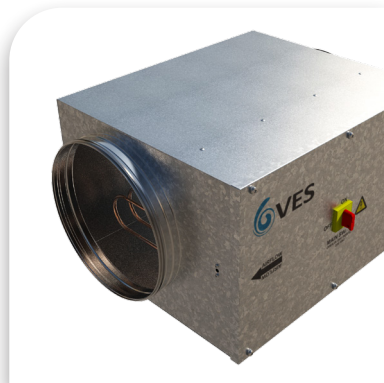

VES Head Office

Eagle Close, Chandlers Ford Industrial Estate, Chandlers Ford, Eastleigh, Hampshire SO53 4NF
Tel: +44 (0) 23 8046 1150 Fax: +44 (0)23 8026 1204

ves.co.uk | sales@ves.co.uk

VES reserves the right to amend product specifications and details without notice.